

4

*strutture  
portanti*

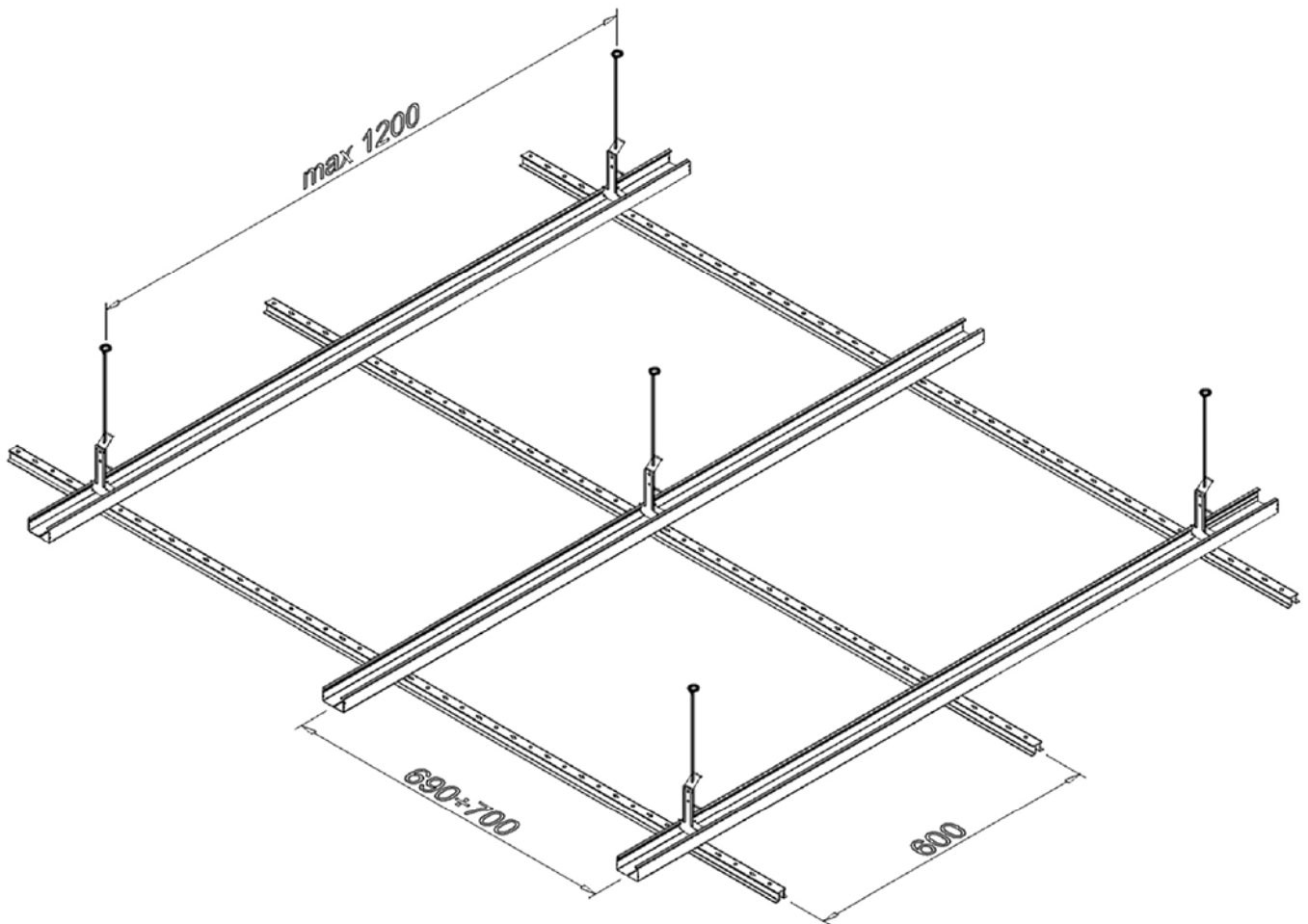

# 1

profilo a omega  
3000 mm

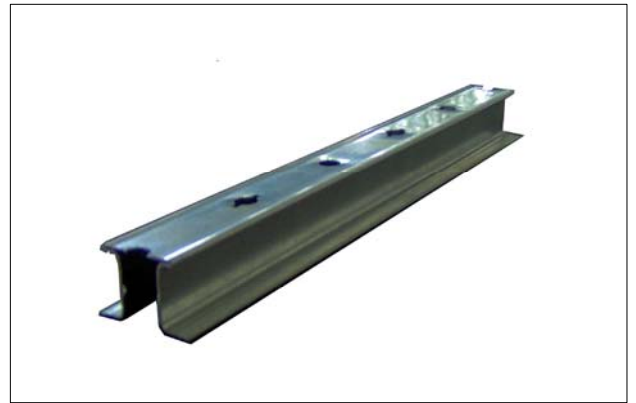
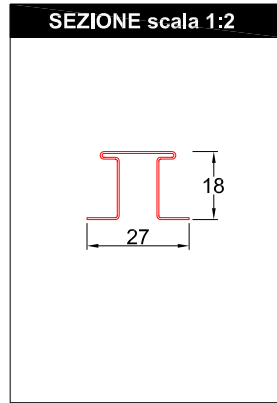

# 2

profilo a C  
4000 mm

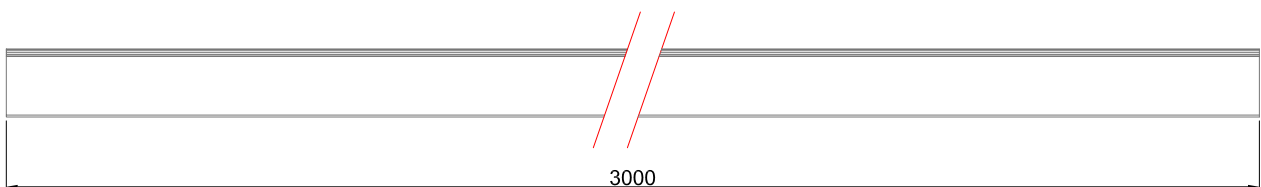
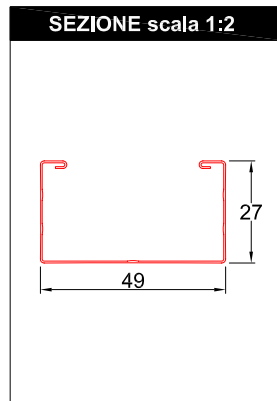

VISTA LATERALE scala 1:2

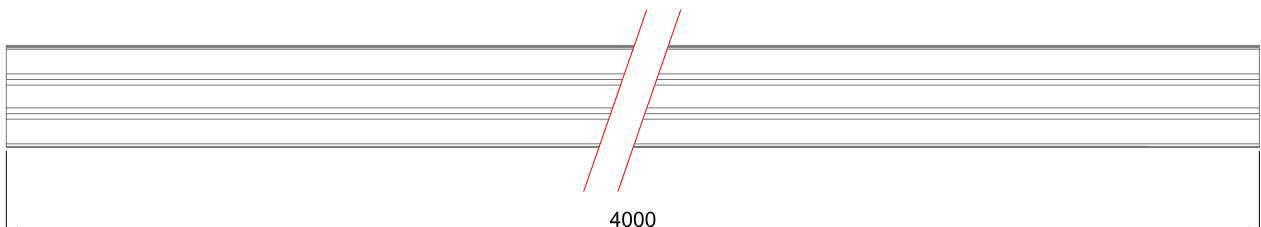

VISTA LATERALE scala 1:2

**patt**

Finiture per interni - strutture portanti per controsoffitti

Patt Spa - Gruppo Fantoni  
tel. +39 0432 976314  
www.pattspa.it  
topakustik@pattspa.it

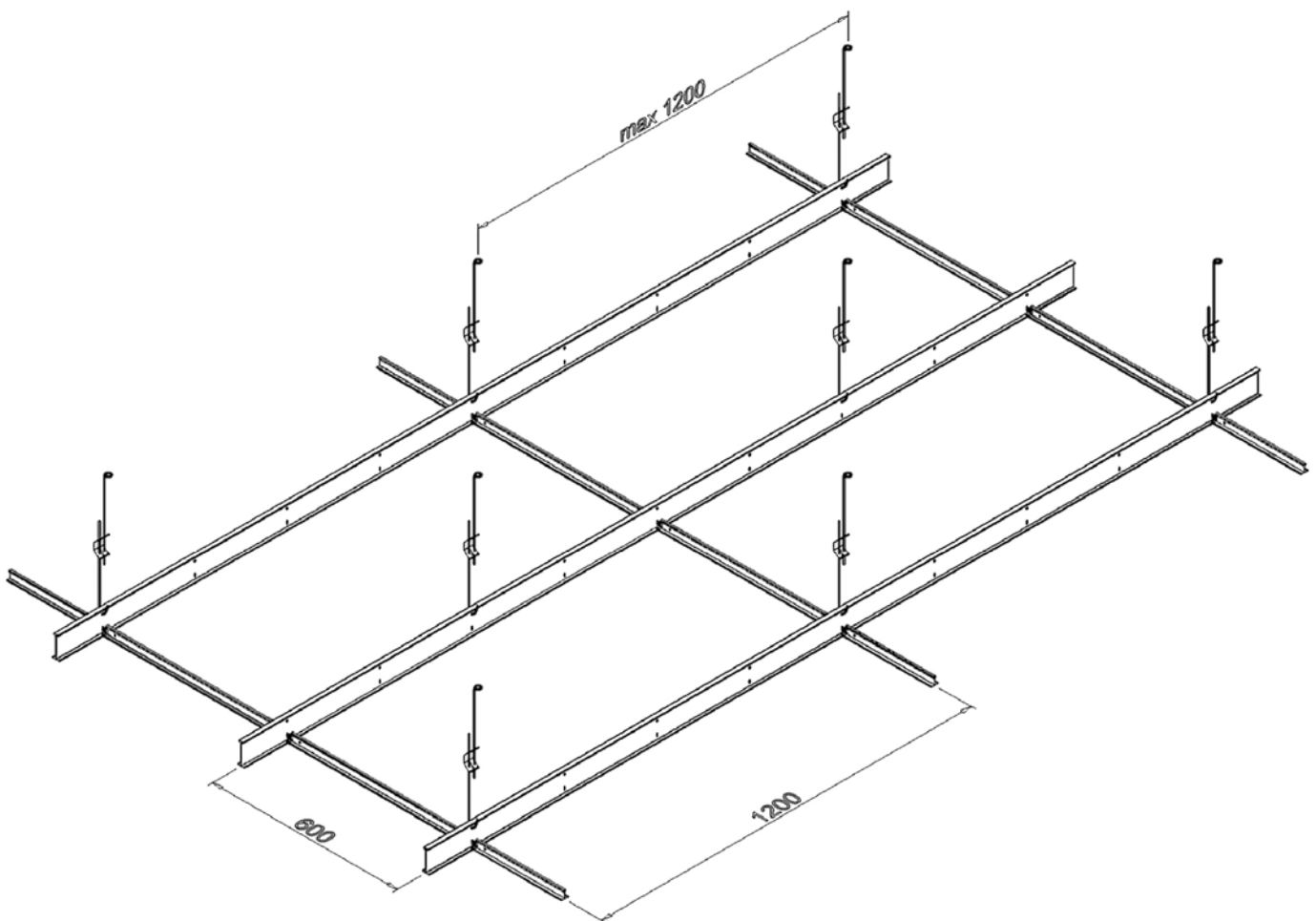

# 1

*DX24 TS60W*  
600 mm

SEZIONE scala 1:2

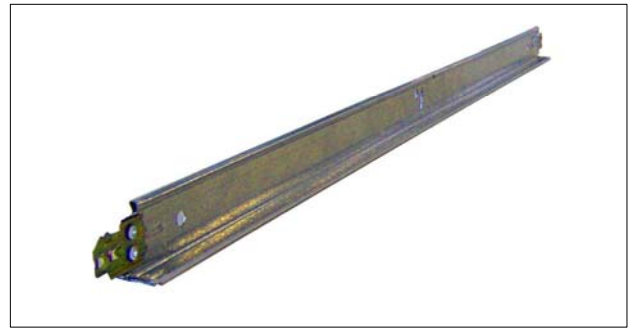
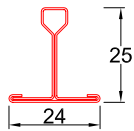

# 2

*DXE24 ZG360W*  
3600 mm

SEZIONE scala 1:2

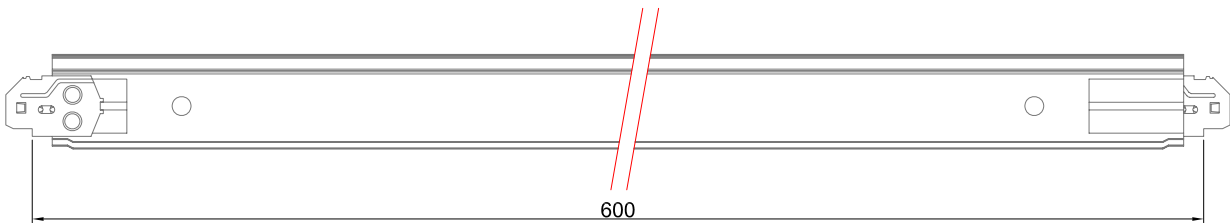
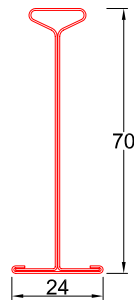

VISTA LATERALE scala 1:2

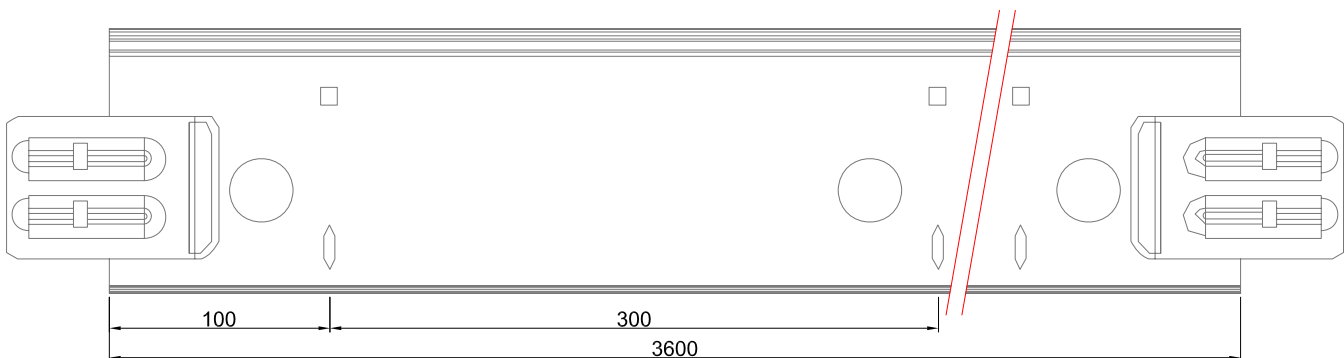

VISTA LATERALE scala 1:2

**patt**

Finiture per interni - strutture portanti per controsoffitti

**Patt Spa - Gruppo Fantoni**  
tel. +39 0432 976314  
[www.pattspa.it](http://www.pattspa.it)  
[topakustik@pattspa.it](mailto:topakustik@pattspa.it)

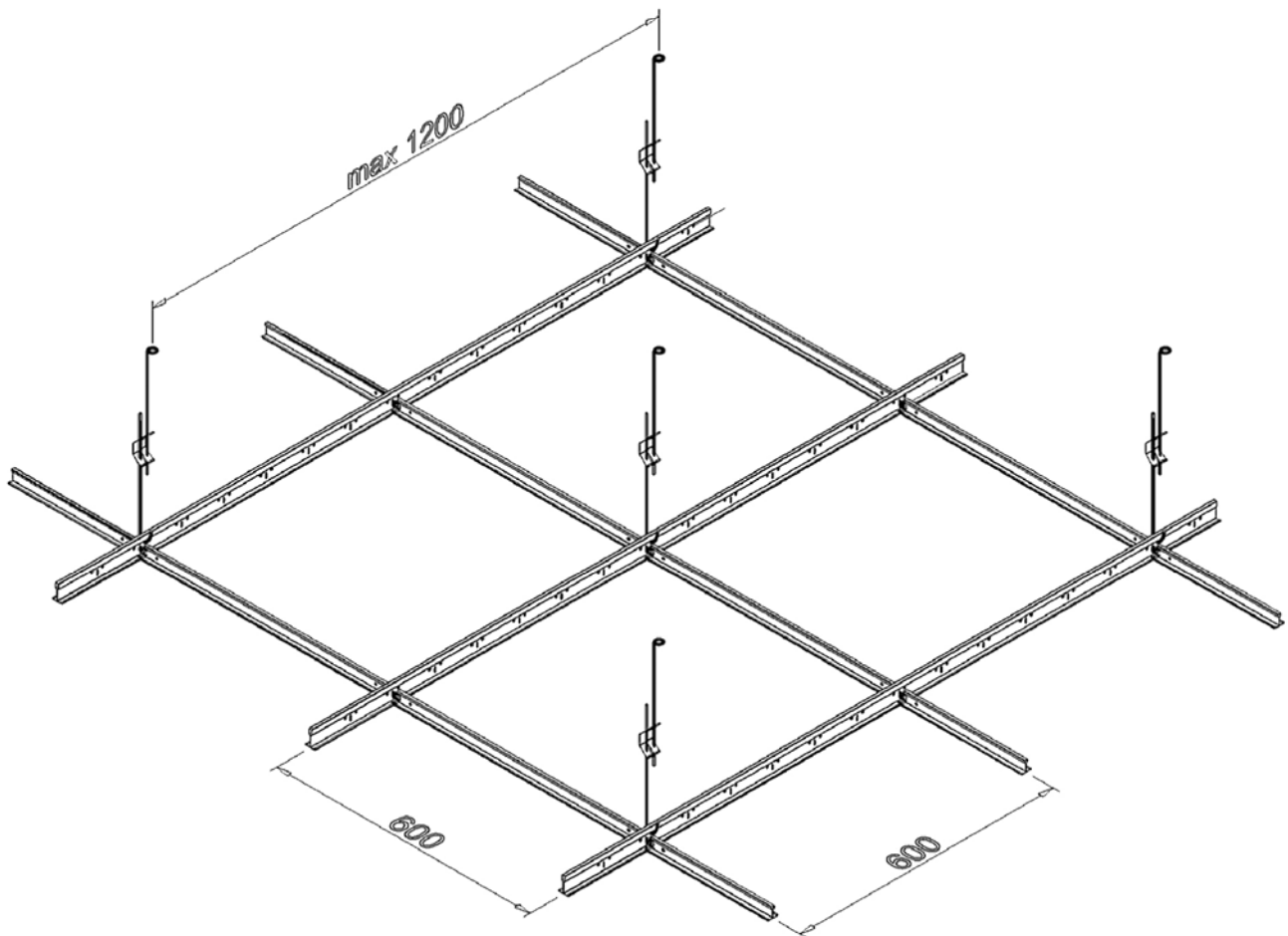

# 1

*DX24 TS60W*  
600 mm

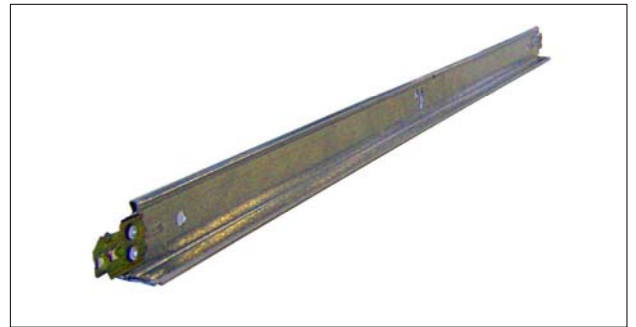
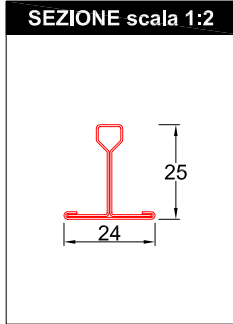

# 2

*DX24 XH370W*  
3700 mm

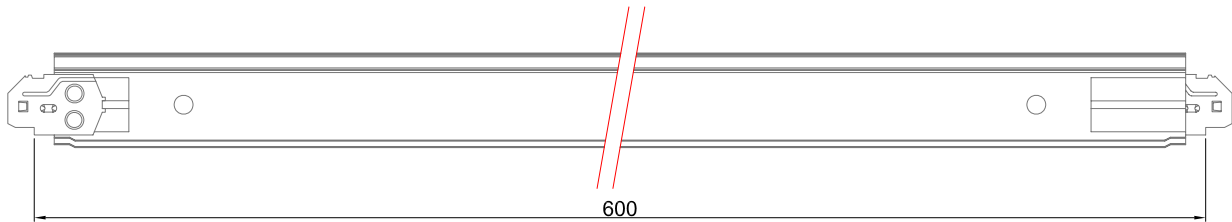
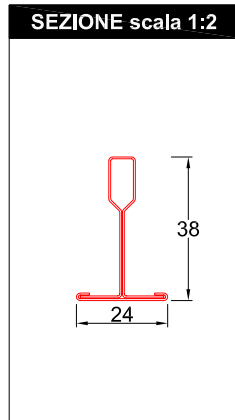

**VISTA LATERALE scala 1:2**

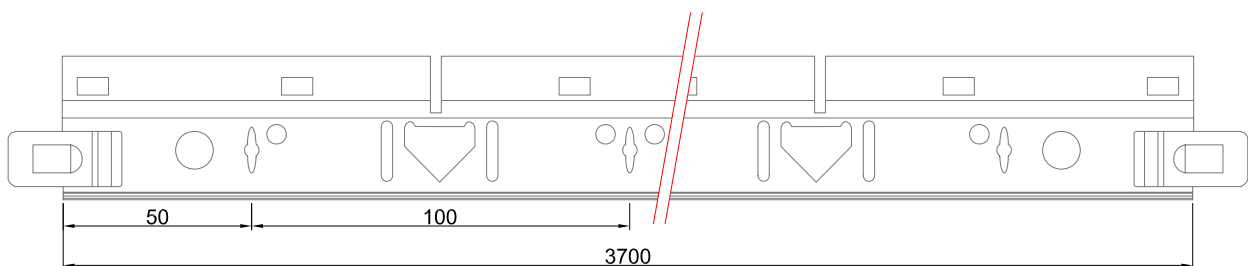

**VISTA LATERALE scala 1:2**

**patt**

Finiture per interni - strutture portanti per controsoffitti

**Patt Spa - Gruppo Fantoni**  
tel. +39 0432 976314  
[www.pattspa.it](http://www.pattspa.it)  
[topakustik@pattspa.it](mailto:topakustik@pattspa.it)